

LINEA SAFETY BARRIERE e SCHERMI DIVISORI ANTI CONTAGIO

NO-INFECTION BARRIERS and PROTECTION SCREEN



SAFETY IS THE FUTURE!

PROFILI IN ALLUMINIO, PROTEZIONI E SISTEMI MODULARI PER APPLICAZIONI INDUSTRIALI EFFICIENTI E SICURE
CUSTOMIZED SOLUTIONS FOR EFFICIENT AND SECURE INDUSTRIAL APPLICATIONS

SCREEN LINE

SCHERMO PROTETTIVO ANTI-DROPLET SCREEN

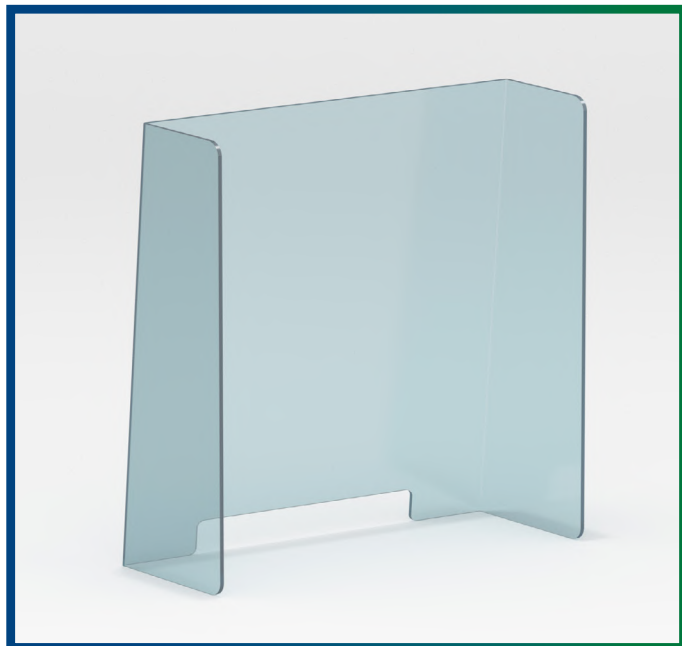
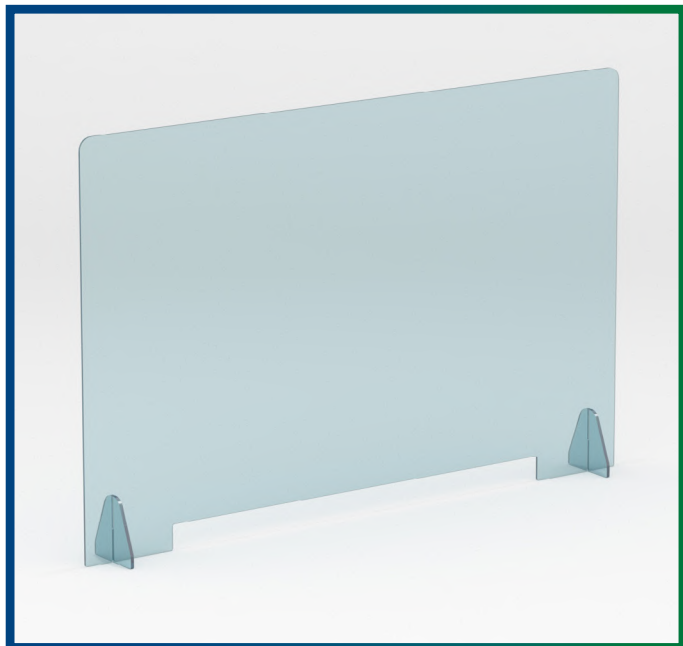

DIMENSIONI SCHERMO / SCREEN SIZES	DIMENSIONI PASSACARTE / PASS-THROUGH SLOT SIZES PASSACARTE / PASS-THROUGH SLOT
L 500 x H 650 mm	L 204 x H 80 mm
L 750 x H 650 mm	L 500 x H 80 mm
L 950 x H 650 mm	L 500 x H 80 mm
L 1.450 x H 650 mm	L 1000 x H 80 mm
L 950 x H 950 mm	L 500 x H 80 mm
L 1.450 x H 950 mm	L 1000 x H 80 mm

CARATTERISTICHE TECNICHE / TECHNICAL DATA

- Pannello in materiale plastico trasparente 5 mm
- Spessore piedini di supporto 8 mm
- Bordini anti-taglio arrotondati con lavorazione a laser
- Transparent plastic material screen 5 mm
- Supporting feet thickness 8 mm
- Anti-cut edges by laser processing

TUTTI I MODELLI DELLA LINEA SCREEN SONO DISPONIBILI CON E SENZA FESSURA PASSACARTE.
SCREEN LINE: ALL MODELS AVAILABLE WITH AND WITHOUT PASS THROUGH SLOT

TUTTE LE MISURE SONO PERSONALIZZABILI
ALL SIZES ARE CUSTOMIZABLE

SAFETY IS THE FUTURE!

PROFILI IN ALLUMINIO, PROTEZIONI E SISTEMI MODULARI PER APPLICAZIONI INDUSTRIALI EFFICIENTI E SICURE
CUSTOMIZED SOLUTIONS FOR EFFICIENT AND SECURE INDUSTRIAL APPLICATIONS

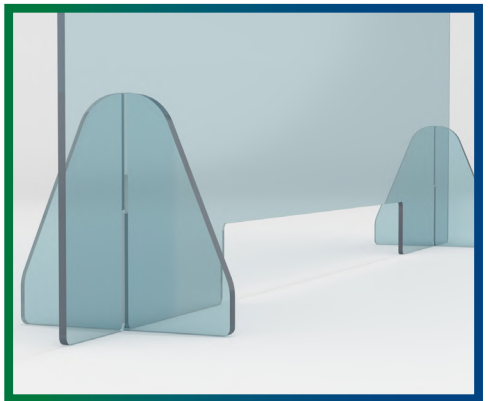
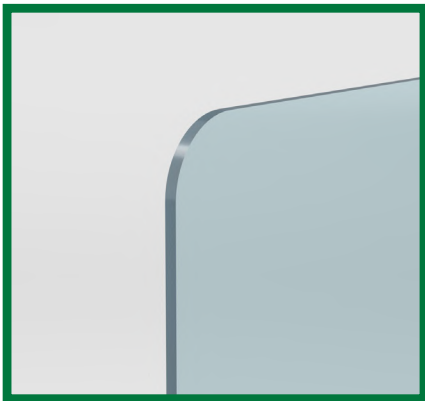
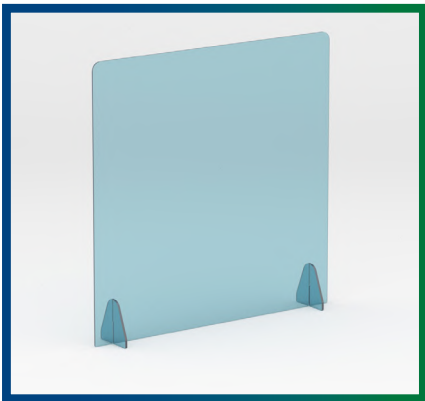
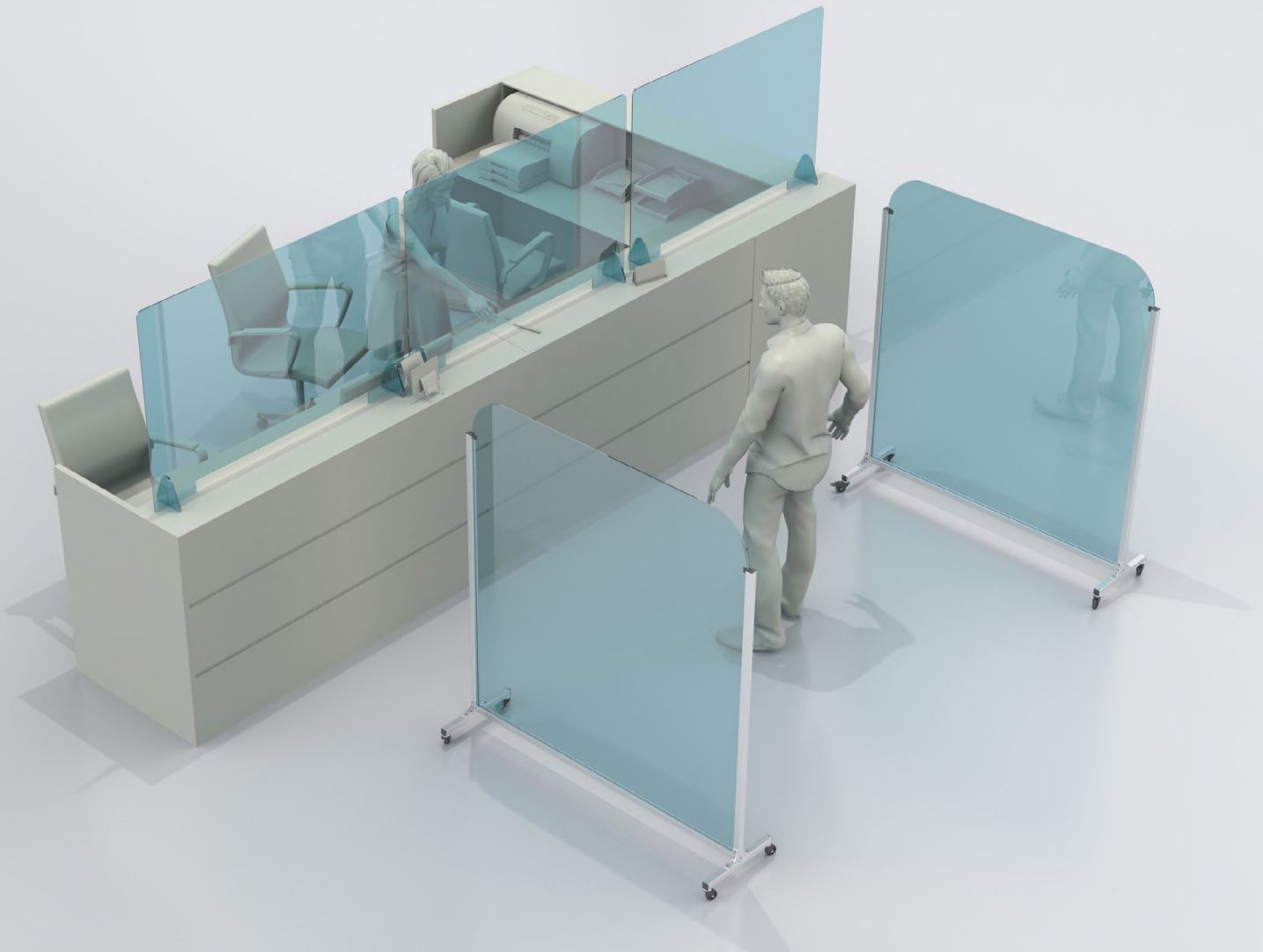

DESK LINE

SCHERMO PROTETTIVO ANTI-DROPLET SCREEN

SCHERMO DA TAVOLO DESIGN XL
DESIGN DESK XL SCREEN

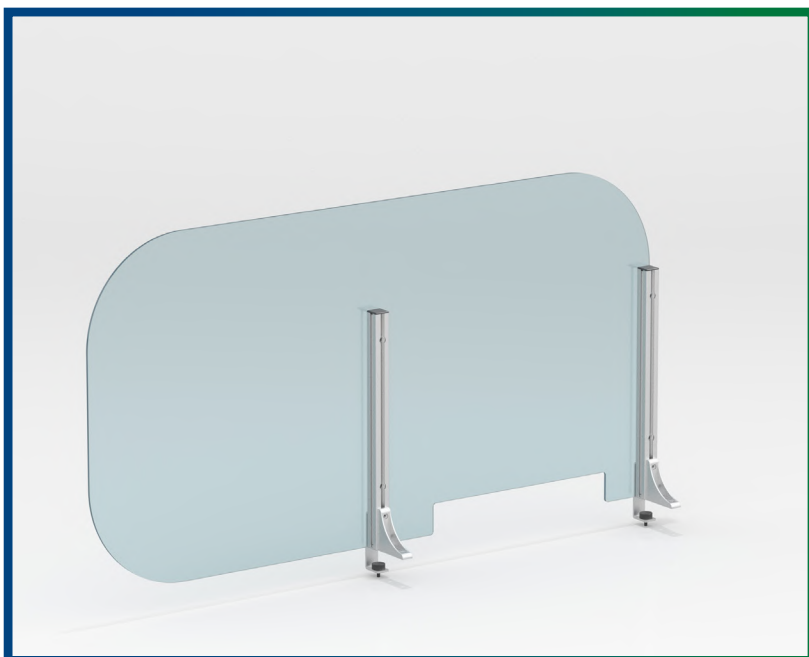

SCHERMO DA TAVOLO DESIGN
DESIGN DESK SCREEN



DIMENSIONI / SIZES

L 800 x H 650 mm

L 1000 x H 650 mm

L 1200 x H 650 mm

L 1400 x H 650 mm

L 1600 x H 650 mm

L 1800 x H 650 mm

CARATTERISTICHE TECNICHE / TECHNICAL DATA

- Pannello in materiale plastico trasparente 5 mm
- Morsetti autoportanti regolabili
- Bordini anti-taglio arrotondati con lavorazione a laser
- Profili in alluminio 30x30 mm
- Transparent plastic material screen 5 mm
- Adjustable supporting clamps
- Anti-cut edges by laser processing
- Aluminum profiles 30x30 mm

TUTTI I MODELLI DELLA LINEA DESK SONO DISPONIBILI CON E SENZA FESSURA PASSACARTE.

DESK LINE: ALL MODELS AVAILABLE WITH AND WITHOUT PASS THROUGH SLOT

TUTTE LE MISURE SONO PERSONALIZZABILI
ALL SIZES ARE CUSTOMIZABLE

SAFETY IS THE FUTURE!

PROFILI IN ALLUMINIO, PROTEZIONI E SISTEMI MODULARI PER APPLICAZIONI INDUSTRIALI EFFICIENTI E SICURE
CUSTOMIZED SOLUTIONS FOR EFFICIENT AND SECURE INDUSTRIAL APPLICATIONS

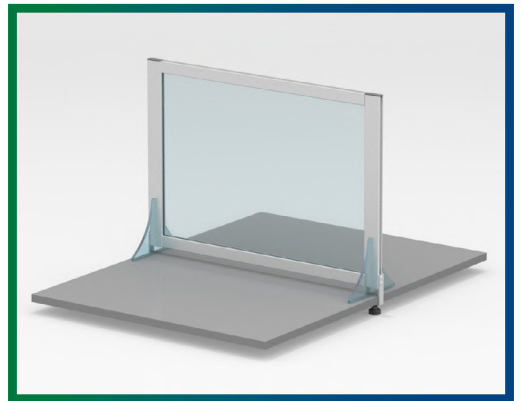
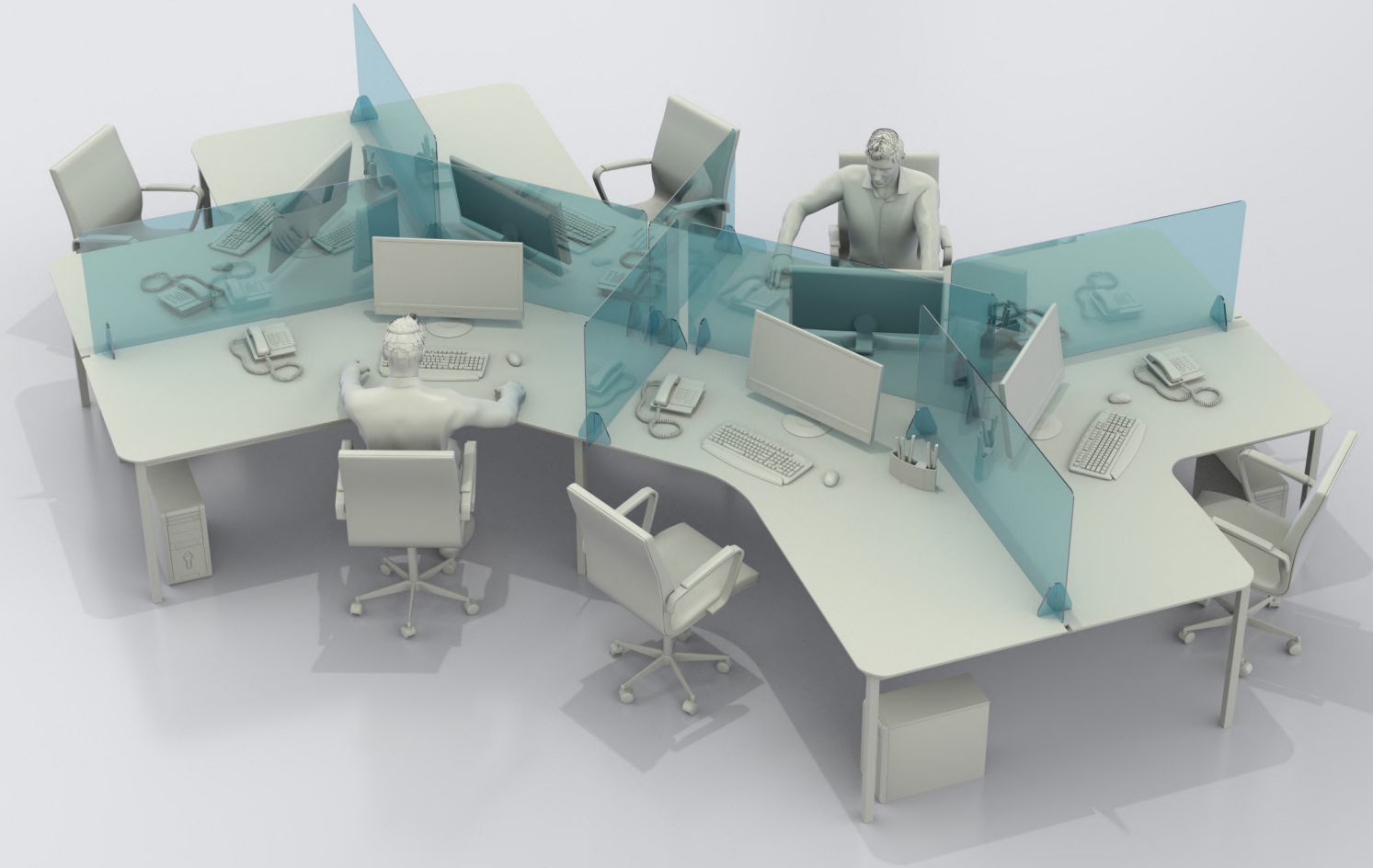

STANDARD LINE

BARRIERA IN POLICARBONATO TRASPARENTE 3 MM

PROTECTION BARRIER IN TRANSPARENT POLYCARBONATE 3 MM

CON PIEDI REGOLABILI IN ALTEZZA
WITH HEIGHT ADJUSTABLE FEET



CON RUOTE GIREVOLI E BLOCCO FRENO
WITH TURNING WHEELS AND BRAKE SYSTEM



CON PIEDI ANTI-INCIAMPO IN INOX
NO-STUMBLE INOX FEET



DIMENSIONI / SIZES

L 1045 x H 2100 mm

L 1545 x H 2100 mm

L 2045 x H 2100 mm

CARATTERISTICHE TECNICHE / TECHNICAL DATA

- Piedini regolabili in altezza
- Ruote girevoli a 360° con blocco freno
- Piedi anti-inciampo in inox
- Profili in alluminio 30x30
- Height adjustable feet
- 360° Turning wheels with brake system
- No-stumble inox feet
- Aluminum profiles 30x30

TUTTE LE DIMENSIONI DELLE STRUTTURE E LE TIPOLOGIE DI PANNELLO SONO PERSONALIZZABILI
ALL STRUCTURE DIMENSIONS AND PANEL TYPE ARE CUSTOMIZABLE

SAFETY IS THE FUTURE!

PROFILI IN ALLUMINIO, PROTEZIONI E SISTEMI MODULARI PER APPLICAZIONI INDUSTRIALI EFFICIENTI E SICURE
CUSTOMIZED SOLUTIONS FOR EFFICIENT AND SECURE INDUSTRIAL APPLICATIONS

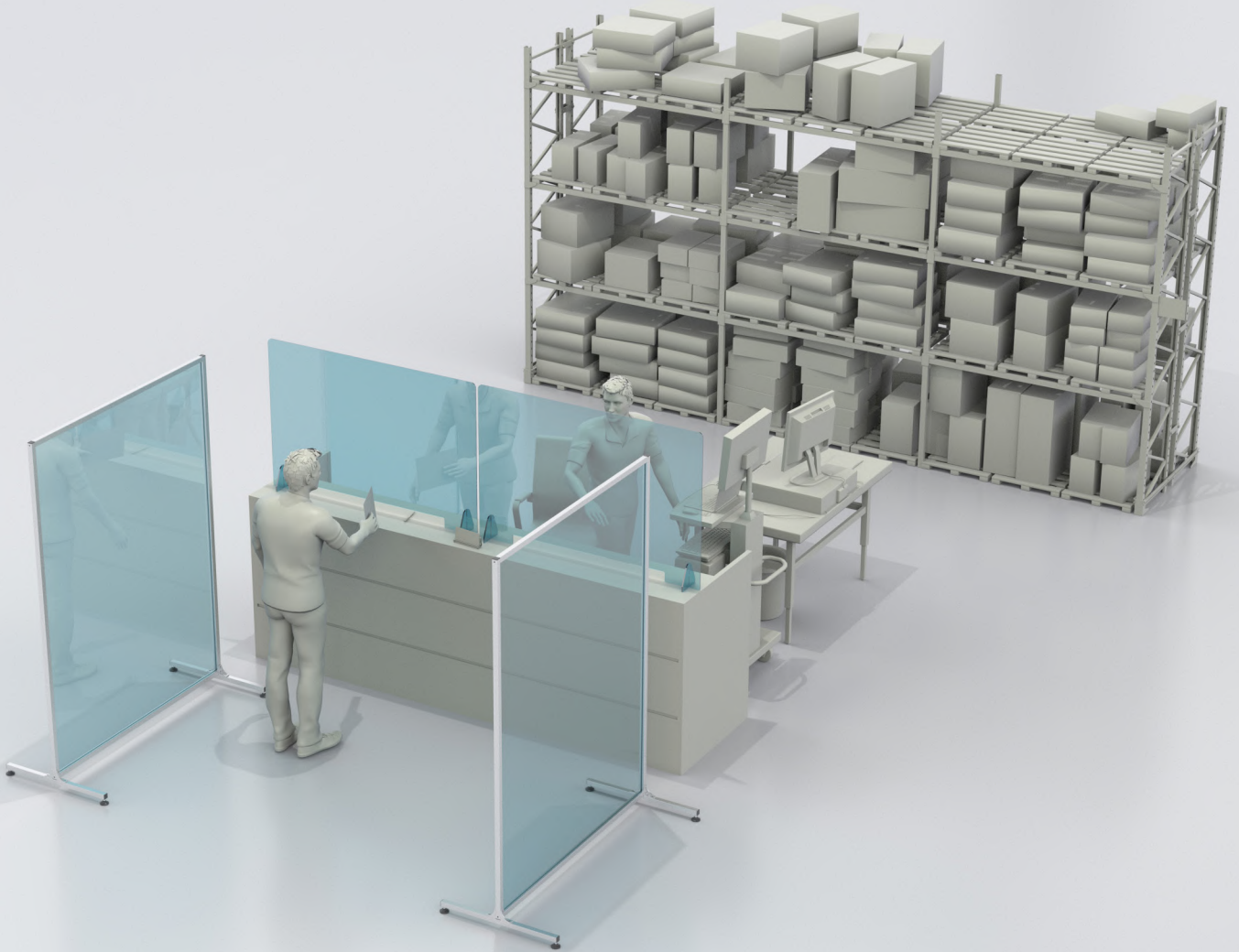

DESIGN LINE

BARRIERA DIVISORIA

PROTECTION BARRIER

DIBOND BIANCO
WHITE DIBOND



POLICARBONATO TRASPARENTE 5MM
TRANSPARENT POLYCARBONATE 5MM



POLICARBONATO FUMÈ 5MM
SMOKY COLOUR POLYCARBONATE 5MM



DIMENSIONI /SIZES
L 1000 x H 1600mm
L 1500 x H 1600 mm
L 2000x H 1600 mm

CARATTERISTICHE TECNICHE / TECHNICAL DATA

- Piedini regolabili in altezza
- Ruote girevoli a 360° con blocco freno
- Piedi anti-inciampo in inox
- Profili in alluminio 30x30
- Height adjustable feet
- 360° Turning wheels with brake system
- No-stumble inox feet
- Aluminum profiles 30x30

TUTTE LE DIMENSIONI DELLE STRUTTURE E LE TIPOLOGIE DI PANNELLO SONO PERSONALIZZABILI
ALL STRUCTURE DIMENSIONS AND PANEL TYPE ARE CUSTOMIZABLE

SAFETY IS THE FUTURE!

PROFILI IN ALLUMINIO, PROTEZIONI E SISTEMI MODULARI PER APPLICAZIONI INDUSTRIALI EFFICIENTI E SICURE
CUSTOMIZED SOLUTIONS FOR EFFICIENT AND SECURE INDUSTRIAL APPLICATIONS

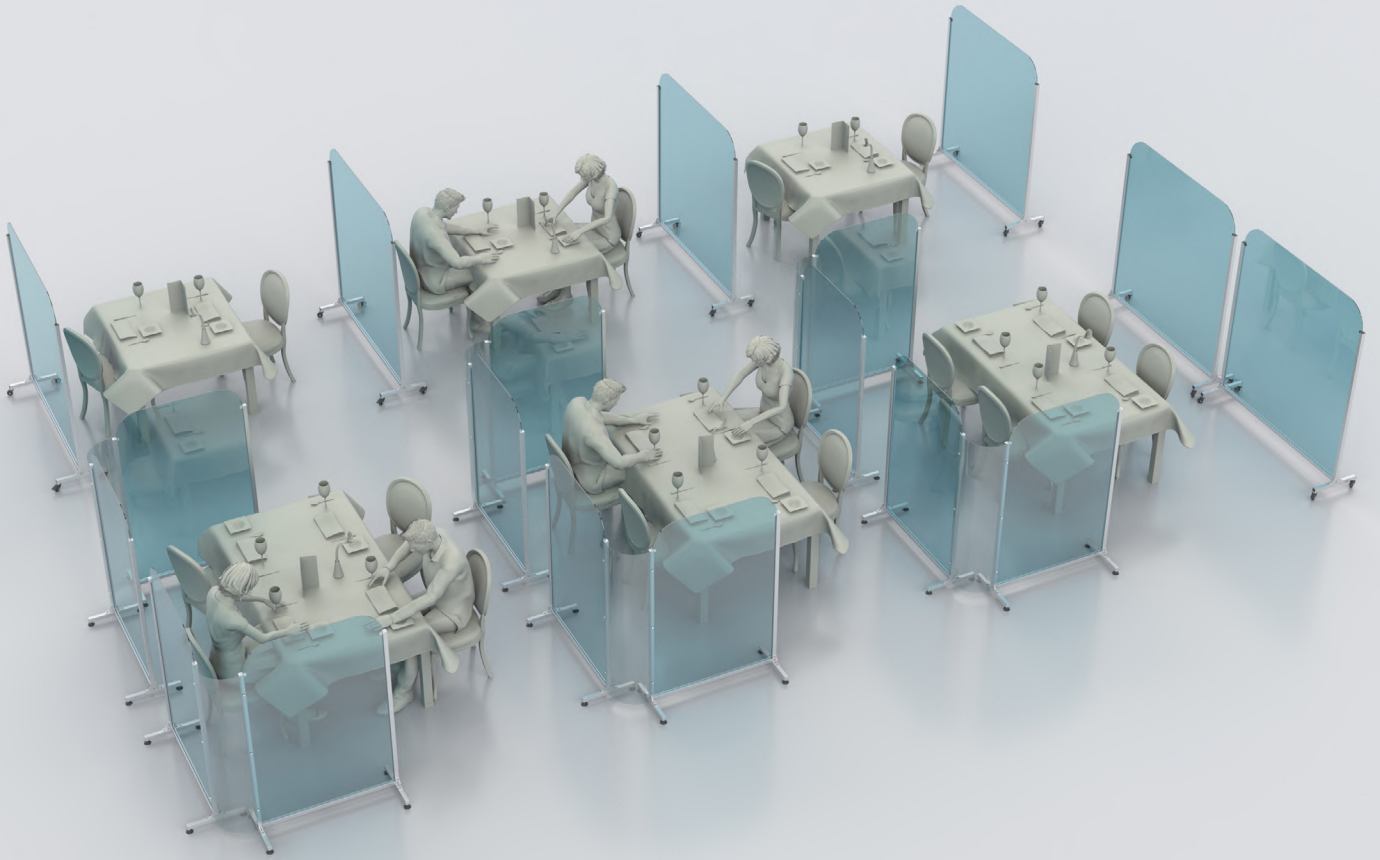

FULL TRANSPARENT LINE

BARRIERA IN MATERIALE PLASTICO TRASPARENTE

PLASTIC MATERIAL TRANSPARENT BARRIER

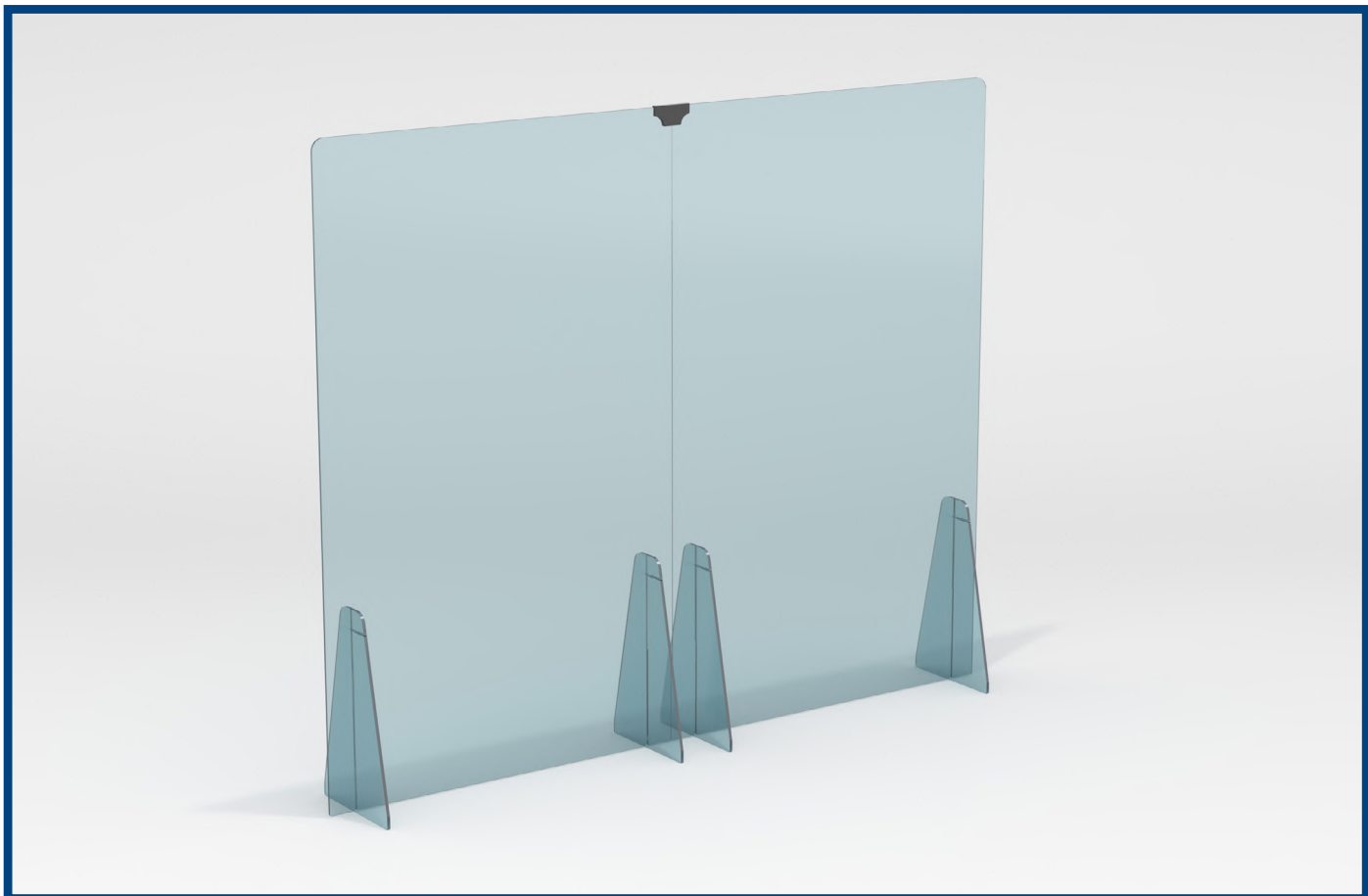

DIMENSIONI / SIZES
L 950 x H 1600 mm

CARATTERISTICHE TECNICHE / TECHNICAL DATA

- Materiale plastico trasparente 8 mm
- Piedi di supporto in materiale plastico trasparente 8 mm
- Morsetto di allineamento per soluzioni modulari
- Transparent plastic material 8 mm
- Supporting feet in transparent plastic material 8 mm
- Alignment clamp for modular solutions

TUTTE LE DIMENSIONI DELLE STRUTTURE E LE TIPOLOGIE DI PANNELLO SONO PERSONALIZZABILI
ALL STRUCTURE DIMENSIONS AND PANEL TYPE ARE CUSTOMIZABLE

SAFETY IS THE FUTURE!

PROFILI IN ALLUMINIO, PROTEZIONI E SISTEMI MODULARI PER APPLICAZIONI INDUSTRIALI EFFICIENTI E SICURE
CUSTOMIZED SOLUTIONS FOR EFFICIENT AND SECURE INDUSTRIAL APPLICATIONS

WRAP LINE

VERSIONE ECONOMICA. GRAZIE ALLE RIDOTTE DIMENSIONI DI IMBALLO E FACILITÀ DI MONTAGGIO IN TOTALE AUTONOMIA. ECONOMIC AND EASY TO ASSEMBLE. SMALL PACKAGING SIZE.



DIMENSIONI / SCREEN	DIMENSIONI / SIZES CON PVC H. 1200
L 1000 x H 1800 mm	L 1000 x H 1800 mm
L 1500 x H 1800 mm	L 1500 x H 1800 mm
L 2000 x H 1800 mm	L 2000 x H 1800 mm

CARATTERISTICHE TECNICHE / TECHNICAL DATA

- PVC avvolgibile trasparente
- Fornito smontato dotato di kit di montaggio
- Piedi anti-inciampo in inox
- Ridotte dimensioni di imballo
- Transparent roll-up PVC
- Disassembled. Provided with self-assembling kit
- No-stumble inox feet
- Small packaging sizes.

COLONNINA PORTA GEL IGIENIZZANTE

PORTA DISPENSER PER GEL IGIENIZZANTE CON ESPOSITORE E CASSETTO PORTA GUANTI

DISPENSER HOLDER FOR HAND SANITIZING GEL WITH
INFO PANEL AND GLOVES HOLDER SUPPORT



DIMENSIONI / SIZES

Base Ø 400 mm

Altezza/Height 1450 mm

CARATTERISTICHE TECNICHE / TECHNICAL DATA

- Telaio in alluminio anodizzato argento
- Supporti portagel e porta guanti in materiale plastico trasparente
- Pannello informativo in materiale plastico trasparente
- Silver anodized aluminum frame
- Gel and gloves supports in transparent plastic material
- Transparent plastic material info panel

SAFETY IS THE FUTURE!

PROFILI IN ALLUMINIO, PROTEZIONI E SISTEMI MODULARI PER APPLICAZIONI INDUSTRIALI EFFICIENTI E SICURE
CUSTOMIZED SOLUTIONS FOR EFFICIENT AND SECURE INDUSTRIAL APPLICATIONS

TIPOLOGIE DI PANNELLI: PANELS TYPE:

LINEA STANDARD

POLICARBONATO TRASPARENTE 3MM / TRANSPARENT POLYCARBONATE 3MM



POLICARBONATO ALVEOLARE SEMITRASPARENTE 6MM
SEMITRASPARENTE ALVEOLAR POLYCARBONATE 6MM



LINEA DESIGN

POLICARBONATO TRASPARENTE E FUMÈ 5MM
TRANSPARENT/SMOKY COLOUR POLYCARBONATE 5MM



DIBOND BIANCO 3MM / WHITE DIBOND 3MM



WRAP LINE

PVC TRASPARENTE / TRANSPARENT PVC



BARRIERE E SCHERMI DIVISORI ANTI CONTAGIO

NO-INFECTION BARRIERS AND PROTECTION SCREEN

VANTAGGI / ADVANTAGES

VERSATILITÀ DI UTILIZZO:

facili da montare e da spostare

PERSONALIZZABILI:

formati su misura per soddisfare tutte le esigenze

EFFICIENTE PROTEZIONE IMMEDIATA:

barriera di difesa impermeabile a ogni virus a trasmissione aerea

EFFICACE PREVENZIONE PER IL FUTURO:

una sana abitudine anche per il futuro

VERSATILITY OF USE:

easy to assemble and move

CUSTOMIZABLE:

fully customizable to satisfy all needs

EFFICIENT AND IMMEDIATE PROTECTION:

protection barrier for any type of air transmission virus

CONCRETE PREVENTION FOR THE FUTURE:

a healthy habit now and in the future

SETTORI DI APPLICAZIONE / APPLICATION FIELDS

OGNI TIPO DI ATTIVITÀ E SETTORE:

- Uffici e ricevimento Merci
- Istituti Bancari e Assicurativi
- Negozi di ogni genere (alimentari, ferramenta, cartolerie, tabaccherie, abbigliamento, accessori, etc.)
- Farmacie, Parafarmacie, Erboristerie, Sanitarie, etc.
- Reception (Hotel, Aziende pubbliche e private, Turismo, Studi Medici, Segreterie, etc.)
- Supermercati e Ipermercati
- Magazzini e linee di produzione
- **Qualsiasi tipologia di postazione di lavoro**

EACH TYPE OF SECTOR AND ACTIVITY:

- Offices and Receiving goods reception
- Banking and Insurance Institutes
- Shops (Food, Hardware, Stationery, Tobacconists, Clothing, Accessories, Hairstyling, etc.)
- Pharmacies, Herbalists, Healthcare, etc.
- Reception (Hotel, Public and Private companies, Tourism, Medical Offices, Secretaries, etc.)
- Supermarkets and Malls
- Warehouses, Production and Assembling Lines, etc.
- **Any type of workplace**

PULIZIA / CLEANING

SI CONSIGLIA L'UTILIZZO DEL SEGUENTE SPRAY ANTI-STATICO PER LA PULIZIA ORDINARIA AL FINE DI NON ROVINARE LE SUPERFICI

USE THE FOLLOWING ANTISTATIC SPRAY TO CLEAN AND NOT DAMAGE THE SURFACES

DESCRIZIONE / DESCRIPTION	COD.
SPRAY ANTISTATICO CLEAN PLAST	CMFZZ0000001

SI RACCOMANDA ESPRESSAMENTE DI PULIRE LE SUPERFICI CON ACQUA, SAPONE E PANNO IN MICROFIBRA.
IT IS STRICTLY RECOMMENDED TO CLEAN ALL THE SURFACES WITH WATER, SOAP AND MICROFIBRE CLOTH.

MATERIALI 100% RICICLABILI / 100% RECYCLABLE

DL 34 RILANCIO del 19/05/2020

Art. 125 - Riconosce il CREDITO DI IMPOSTA PER LA SANIFICAZIONE E L'ACQUISTO DI DISPOSITIVI DI PROTEZIONE finalizzati a favorire l'adozione delle misure necessarie a contenere e contrastare la diffusione del virus Covid-19.

SAFETY IS THE FUTURE!

PROFILI IN ALLUMINIO, PROTEZIONI E SISTEMI MODULARI PER APPLICAZIONI INDUSTRIALI EFFICIENTI E SICURE
CUSTOMIZED SOLUTIONS FOR EFFICIENT AND SECURE INDUSTRIAL APPLICATIONS

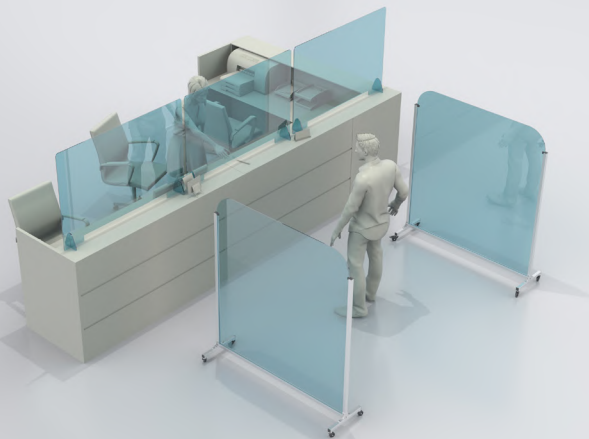

RECEPTIONS



OPENSPACES

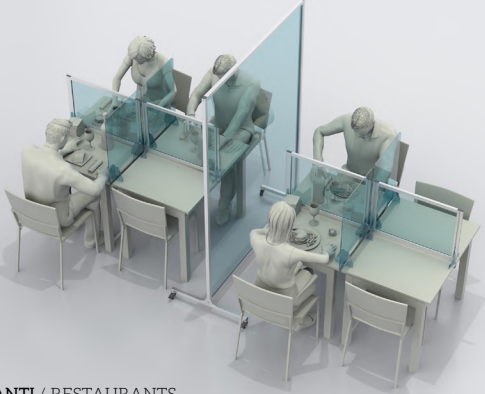

RISTORANTI / RESTAURANTS

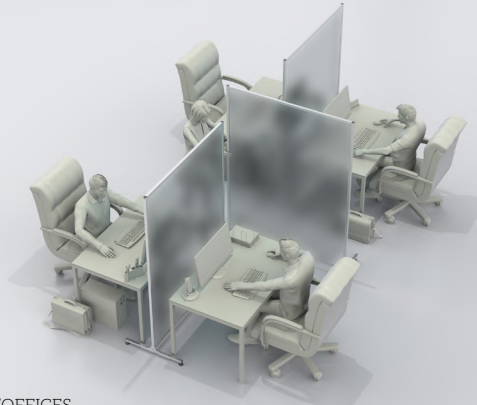

UFFICI / OFFICES

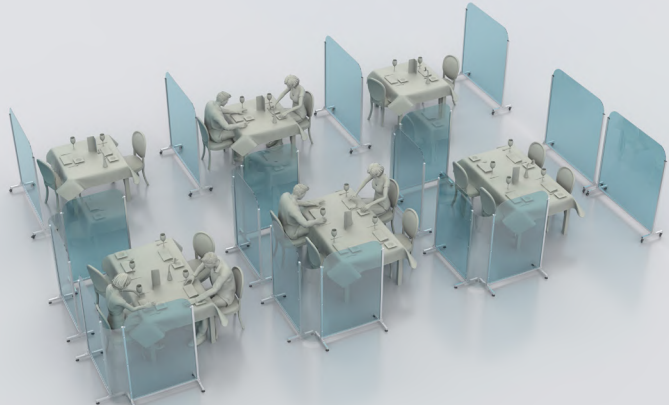

RISTORANTI / RESTAURANTS

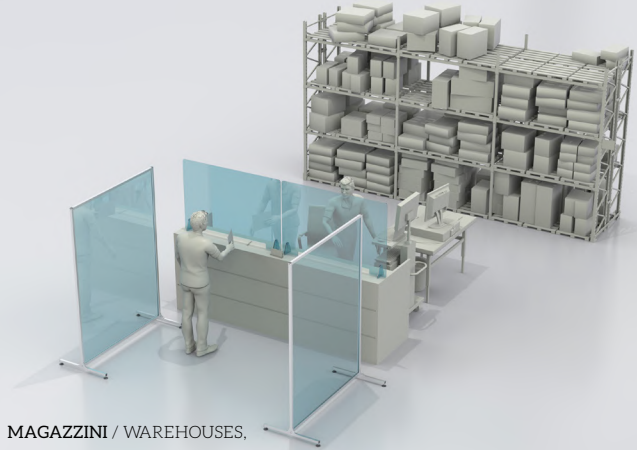

MAGAZZINI / WAREHOUSES.

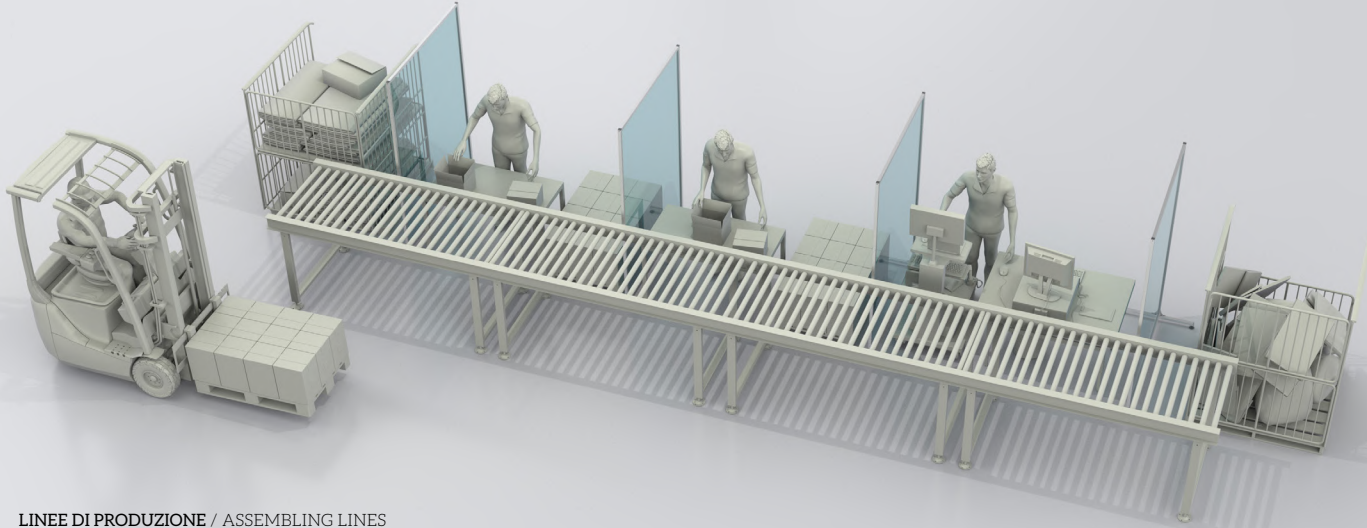

LINEE DI PRODUZIONE / ASSEMBLING LINES

DIERRE S.P.A.

HEADQUARTER FIORANO
Circ. S. Giovanni Ev., 23
41042 Spezzano di Fiorano (MO)
Tel. +39 0536.92.29.11
info@dierre.eu

STABILIMENTO MACAP

Sede Operativa Dierre S.p.A.
Via del Selciatore, 12
40127 Bologna
Tel. +39 051.60.36.811
info@dierre.eu

STABILIMENTO MOTION

Sede Operativa Dierre S.p.A.
Via Industria, 8-10
40050 Argelato (BO)
Tel. +39 051.66.34.711
info@dierremotion.com

STABILIMENTO ARI metal

Sede Operativa Dierre S.p.A.
Via G. Marconi, 8
23843 Dolzago (LC)
Tel. +39 0341.45.34.11
arimetal@arimetal.it

DIERRE TOSCANA srl

Via Siena, 11
59013 Oste-Montemurlo (PO)
Tel. +39 0574.72.20.61
info@dierretoscana.com

DIERRE DECATECH srl

Via Marconi, 2/B
35010 Borgoricco (PD)
Tel. +39 049.93.36.019
info@dierredcatech.com

STABILIMENTO MALO

Sede Operativa Dierre Decatech s.r.l.
Via Tolomeo, 10
36034 Malo (VI)
Tel. +39 0445.58.10.89
info@bassaneseptezioni.com

ILTRAS srl

Via Lago di Misurina, 64
36015 Schio (VI)
Tel. +39 0445.57.53.57
info@iltras.it

DIERRE ROBOTICS srl

SEDE OPERATIVA
Via Dell'Industria 67
Z.I. Corte Tegge
42025 Cavriago (RE)
Tel. +39 0522.94.11.02
Info@dierrerobotics.com

SINTESI srl

Via Irpinia, 64
35020 Saonara (PD)
Tel. + 39 049. 879.06.66
sintesi@sintesi.eu

